

Curtain PIR Motion Detector

PIR-800

Operation Manual

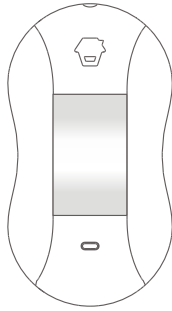

Introduction

The detector works based on detecting human body's infrared spectrum. When human moves within the scope, the detector receives the signal and inputs it into microprocessor after magnification. Microprocessor continues to sample infrared signal and send wireless signal to wireless control panel after calculating. Thus to form a security system. The product can be applied in balcony, window, door and corridor etc.

Features

Accurate Detection

Digital dual-core fuzzy logic infrared control processing technology

Effectively identify interference signals from body movement signals through intelligent analysis

Compact Design

Small in size, not much space occupation

European-style design, adding artistic beauty to your home

Flexible Installation

Ceiling mounted or wall mounted for option

Energy-saving

Featured energy-saving mode enables 1 year standby

Appearance

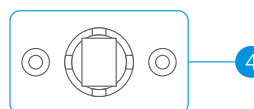
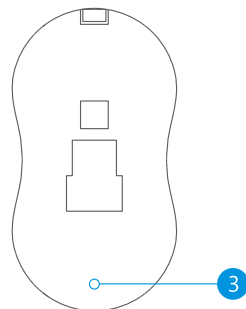
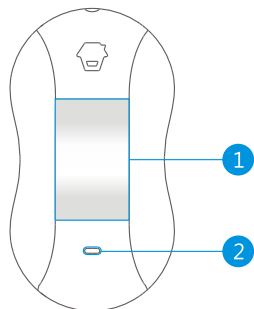

1. Detection Lens
2. LED Indicator
3. Test Button
4. Bracket

PCB Layout

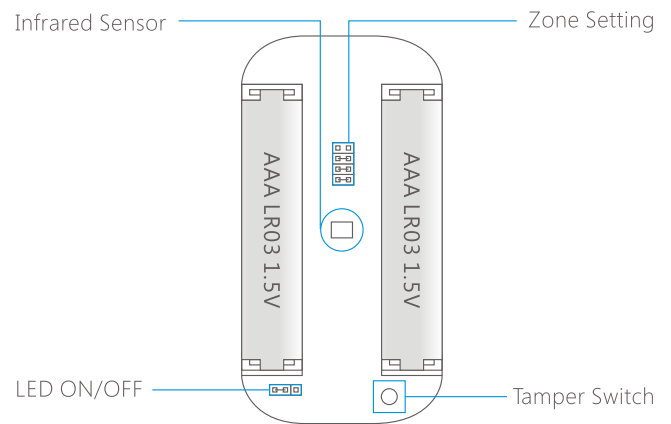

Infrared sensor: Detecting human body's infrared spectrum. Don't touch the surface by hand and keep it clean.

Tamper switch: Once the case is opened in working state, the tamper switch will be triggered and then generates an alarm signal.

LED Indication

The LED indicator can be turned on or off by setting jumpers. See "PCB Layout" above.

Flash continuously: Under self-testing state

Flash once: Intruder is detected

Flash twice: Self-testing is finished, enters working mode

Flash once every 3 seconds: Undervoltage indication, please change the batteries immediately.

Usage

Remove the battery activation strip to activate batteries. It will enter working mode after one-minute's self-testing.

Mode Setting

Testing mode: press test button, the sensor enters testing mode and detects once every 10 seconds. After 3 minutes, the LED flashes twice, the sensor enters the working mode.

Working mode: In working state, if the sensor is triggered twice within 3 minutes, it will enter sleeping mode to save power. After no movement within next 3 minutes, the sensor goes back to the working mode.

Installation & Notice

Wall-mounting:

Fix the bracket longitudinally on the wall, and put the detector on the bracket. Choose to mount it at the entry and exit where intruder possibly breaks into. It is suggested to mount it at the height of 2m from the ground.

Ceiling-mounting:

Fix the bracket laterally on the ceiling upper the door or window, and put the detector on the bracket.

Mount on wall

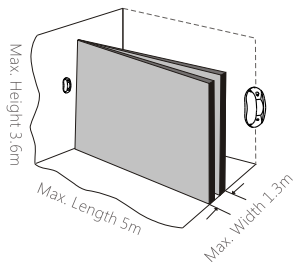

Mount at ceiling

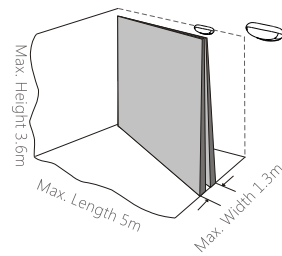

Mount at door

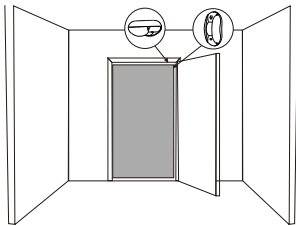

Note: make sure the detection direction towards interior both installed on wall and at ceiling. Adjust the bracket angle to optimize the detecting effect.

Avoid mounting the detector close to air conditioner, electronic fan, refrigerator, oven, heater and objects which will cause fast temperature changing, and avoid mounting it in direct sunlight.

Avoid any objects blocking the lens, so as not to influence the detection effect.

Detection Range

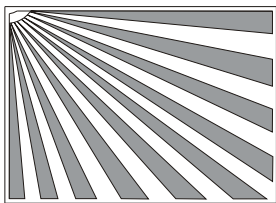

0m

5m

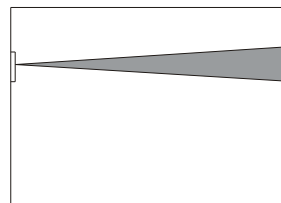

0m

5m

Testing (Walk Test)

After installation, power on the detector. After self-testing for 1 minute, press the test button, walk in the scope by crossing the infrared spectrum (see below diagram), and watch the LED indicator to make sure it is working. The LED indicator will flash once when body movement is detected.

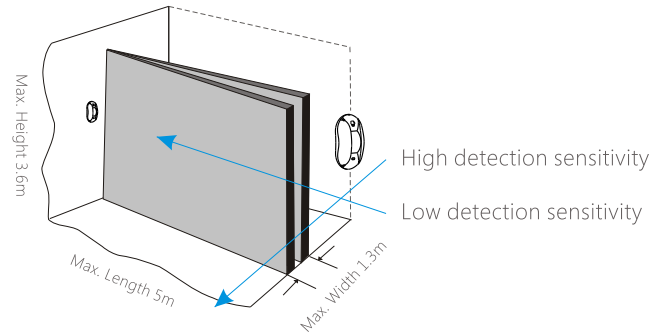

Connect with the Control Panel

When the control panel is in connecting state, press the test button twice to send wireless signal. One beep is heard after panel receives signal, which means successful connection.

Arm the system, trigger the detector again. The panel will alarm immediately. This indicates the detector has successfully connected with the panel.

Specifications

Power Supply:

DC 3V (AAA LR03 1.5V Battery x 2pcs)

Static Current:

≤ 50uA

Alarm Current:

≤ 9.5mA

Detection Distance:

5m

Curtain Detection Angle:

15°

Transmitting Distance:

≤ 80m (in open area)

Radio Frequency:

315MHz or 433MHz (±75KHz)

Housing Material:

ABS Plastic

Operation Condition

Temperature: -10°C ~ +50°C

Relative Humidity: ≤ 80%RH (non-condensing)

Detector Dimensions (L x W x H):

48 x 33 x 88mm

Mounting Plate Dimensions (L x W x H):

52 x 30 x 11.6mm

CHUANGO®

产品型号	PIR-800	部件名称	说明书
设计	林寿	材料	80克书写纸
印刷尺寸	210X285mm	成品尺寸	52.5X95mm
工艺	折页	版本	Ver: 800-EN-1307-2.0

注:
双色、双面印刷
保持产品名称在最上面